

IP65



Serie 770...



1006201

1

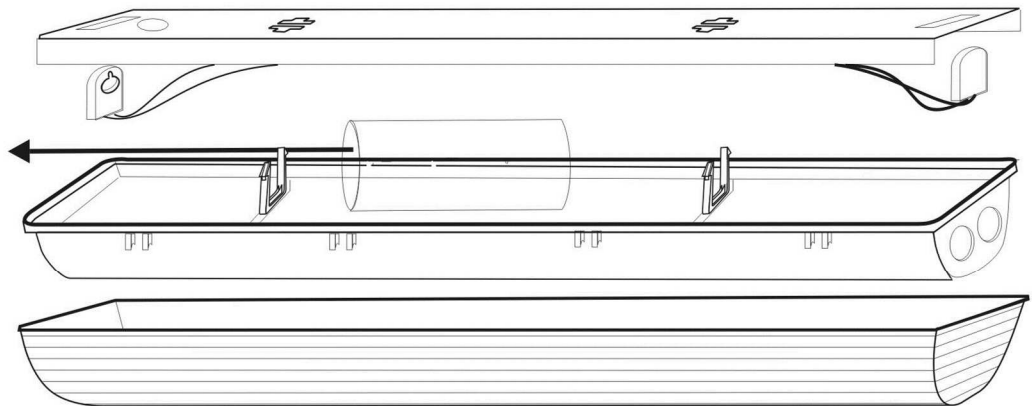
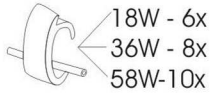
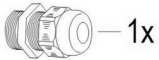

2

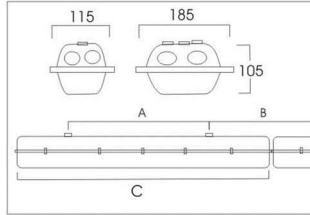
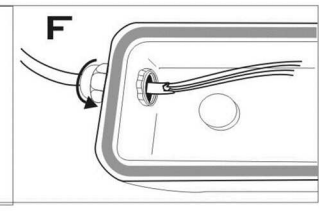
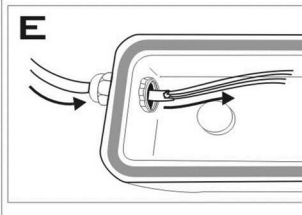
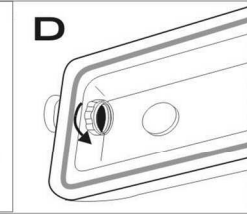
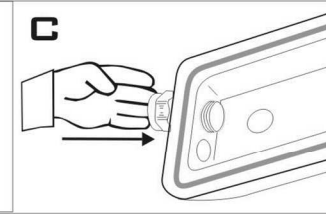
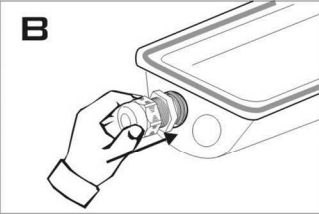
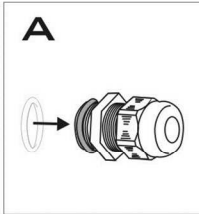

Watt	A	B	C
1 x 18	460	258	668
1 x 36	800	526	1276
1 x 58	1100	526	1576
2 x 18	460	258	668
2 x 36	800	526	1276
2 x 58	1100	526	1576

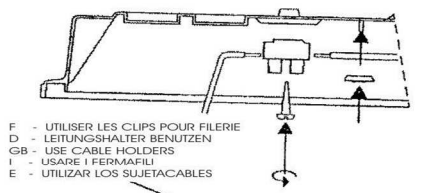
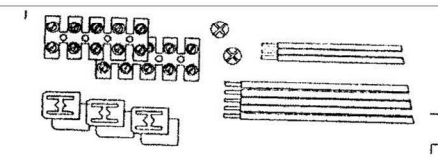

F - UTILISER LES CLIPS POUR FILERIE  
D - LEITUNGSHALTER BENUTZEN  
GB - USE CABLE HOLDERS  
I - USARE I FERMAFI  
E - UTILIZAR LOS SUJETACABLES

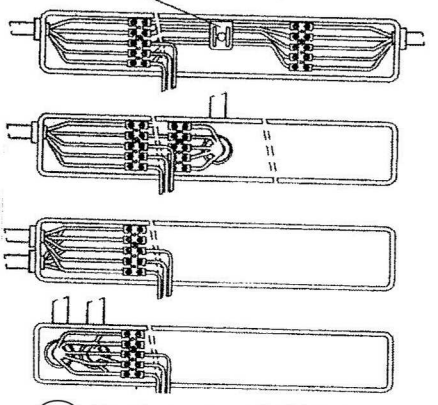

(D) Durchgangsverdrahtung  
(GB) Throughgoing wiring

3

